

# POTAIN IGO T 130

## SELF-ERECTING TOWER CRANE

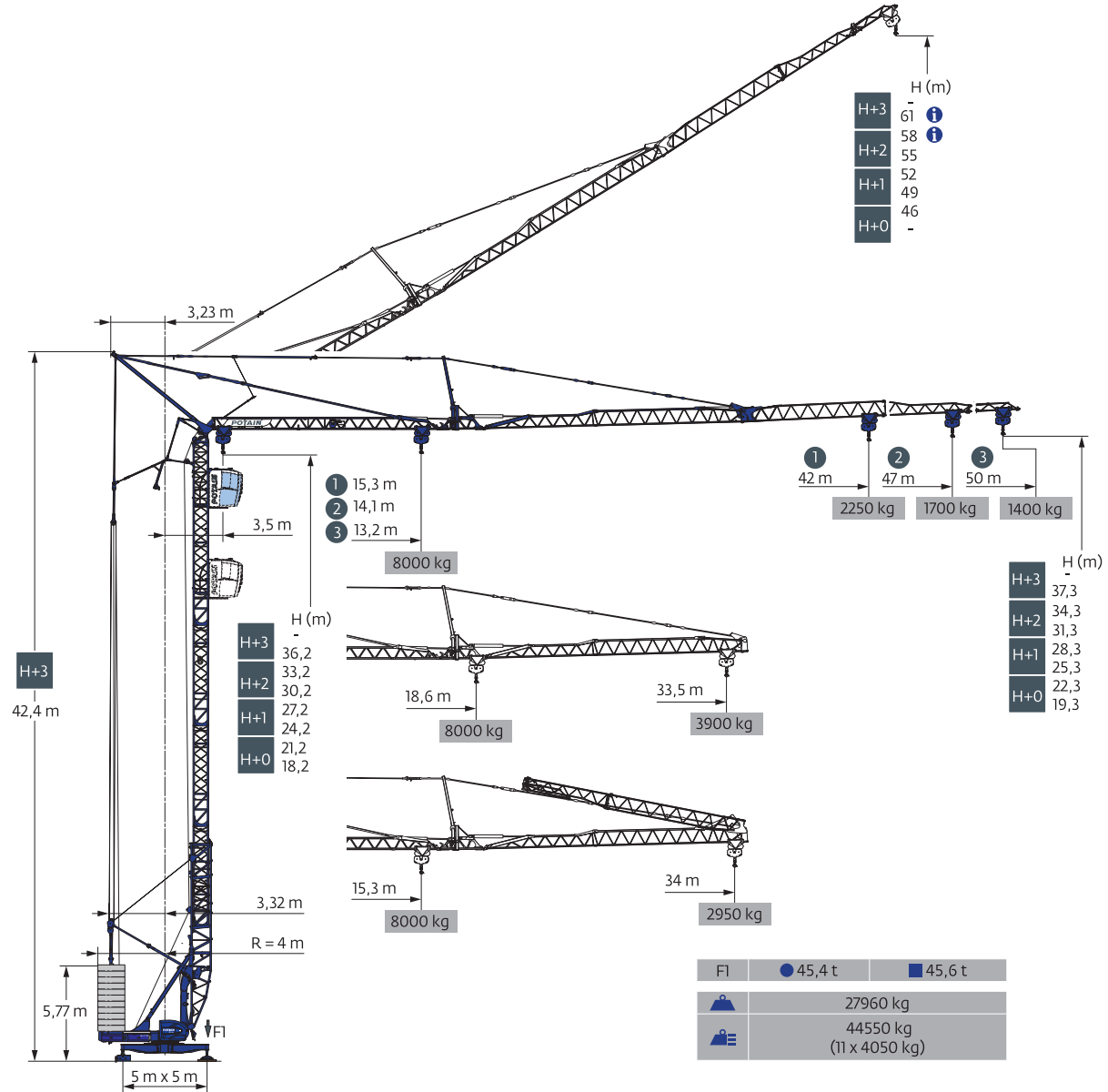



Larger reliable self erecting tower crane with multiple tower heights. Can be delivered and installed in a few hours. Pedestrian operated by radio control.







400 V - 50 Hz 480 V - 60 Hz		👤👤👤							👤👤👤				ch - PS hp	kW
⬆️	33 LVF 20 OPTIMA	m/min	3,2	16	34	53	63	1,6	8	17	26,5	31,5	29,5	22
		kg	2000	2000	2000	1000	500	4000	4000	4000	2000	1000		
⬅️➡️	5 DVF 5	m/min	15 - 30 - 39 - (2000 → 8000kg) 15 - 30 - 55 - (2000 → 2000kg) 15 - 30 - 70 - (0 → 200kg)										5,4	4
🌀	RVF 61 Optima+	tr/min U/min rpm	0 → 0,8										7,5	5,5
⬅️➡️	TVF 124	m/min	25										2x4	2x3

# POTAIN IGO T 130

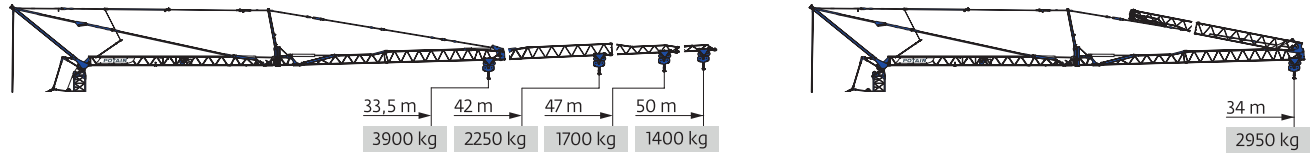
## SELF-ERECTING TOWER CRANE



 IEC 60204-32	 kVA
400 V (+10%-10%) 50 Hz / 480 V (+6% - 10%) 60 Hz	 31 → 19 kVA  35 → 22 kVA





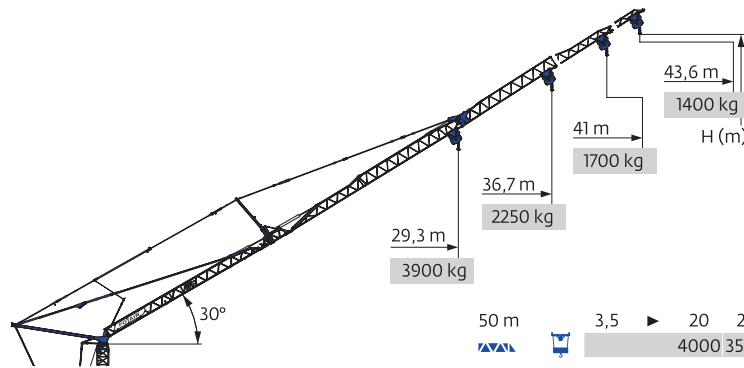

50 m	3,5	▶	13,2	14	16	18	20	22	22,7	23	24	26	28	30	32	34	36	38	40	42	44	46	48	50	m	
			8000	7400	6200	5400	4700	4200	-	3900	3700	3400	3100	2800	2600	2400	2200	2050	1900	1800	1700	1600	1500	1400	kg	
										4000	3900	3700	3400	3100	2800	2600	2400	2200	2050	1900	1800	1700	1600	1500	1400	kg
47 m	3,5	▶	14,1	15	16	18	20	22	24	24,4	25	26	28	30	32	34	36	38	40	42	44	46	47	m		
			8000	7400	6800	5900	5100	4600	4100	-	3900	3700	3400	3100	2850	2600	2450	2250	2100	2000	1850	1750	1700		kg	
											4000	3900	3700	3400	3100	2850	2600	2450	2250	2100	2000	1850	1750	1700	kg	
42 m	3,5	▶	15,3	16	18	20	22	24	25	26	26,7	27	28	30	32	34	36	38	40	42				m		
			8000	7600	6500	5700	5100	4600	4300	4100	-	3900	3800	3500	3200	2950	2750	2550	2400	2250					kg	
											4000	3900	3800	3500	3200	2950	2750	2550	2400	2250					kg	
33,5 m	3,5	▶		18,6	20	22	24	25	26	27	28	30	32	32,8	33,5										m	
				8000	7300	6500	5900	5600	5300	5100	4900	4500	4100	-	3900											kg
														4000	3900											kg

50 m	3,5	▶	15,3	16	18	20	22	24	26	26,7	28	30	32	34	m
47 m			8000	7600	6500	5700	5100	4600	4100	-	3800	3500	3200	2950	kg
42 m										4000	3800	3500	3200	2950	kg



		50 m	47 m	42 m	33,5 m
H+3		61	59,4	-	-
H+2		58	56,4	-	-
		55	53,4	50,7	46,1
H+1		52	50,4	47,7	43,1
		49	47,4	44,7	40,1
H+0		46	44,4	41,7	37,1

50 m	3,5	▶	20	22	24	26	28	30	32	34	36	38	40	42	43,6	m
			4000	3500	3200	2850	2600	2350	2150	2000	1850	1700	1600	1500	1400	kg
47 m	3,5	▶	21,4	22	24	26	28	30	32	34	36	38	41		m	
			4000	3900	3500	3100	2850	2600	2400	2200	2050	1900	1700		kg	
42 m	3,5	▶		23,5	26	28	30	32	34	36,7					m	
				4000	3500	3200	2950	2700	2500	2250					kg	
33,5 m	3,5	▶			28,8	29,3									m	
					4000	3900									kg	

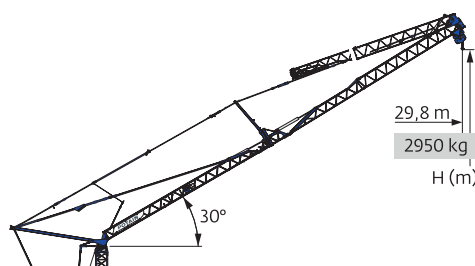

50 m																
47 m	3,5	▶	23,4	24	26	28	29,8									m
42 m			4000	3900	3500	3200	2950									kg

	50 m
	47 m
	42 m
H+2	46,4
	43,4
H+1	40,4
	40,4
H+0	37,4